

4

3

2

1

A

B

C

D

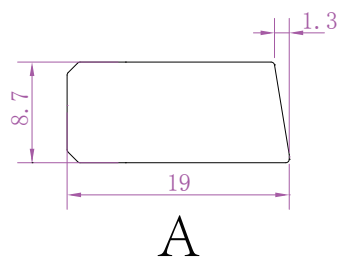
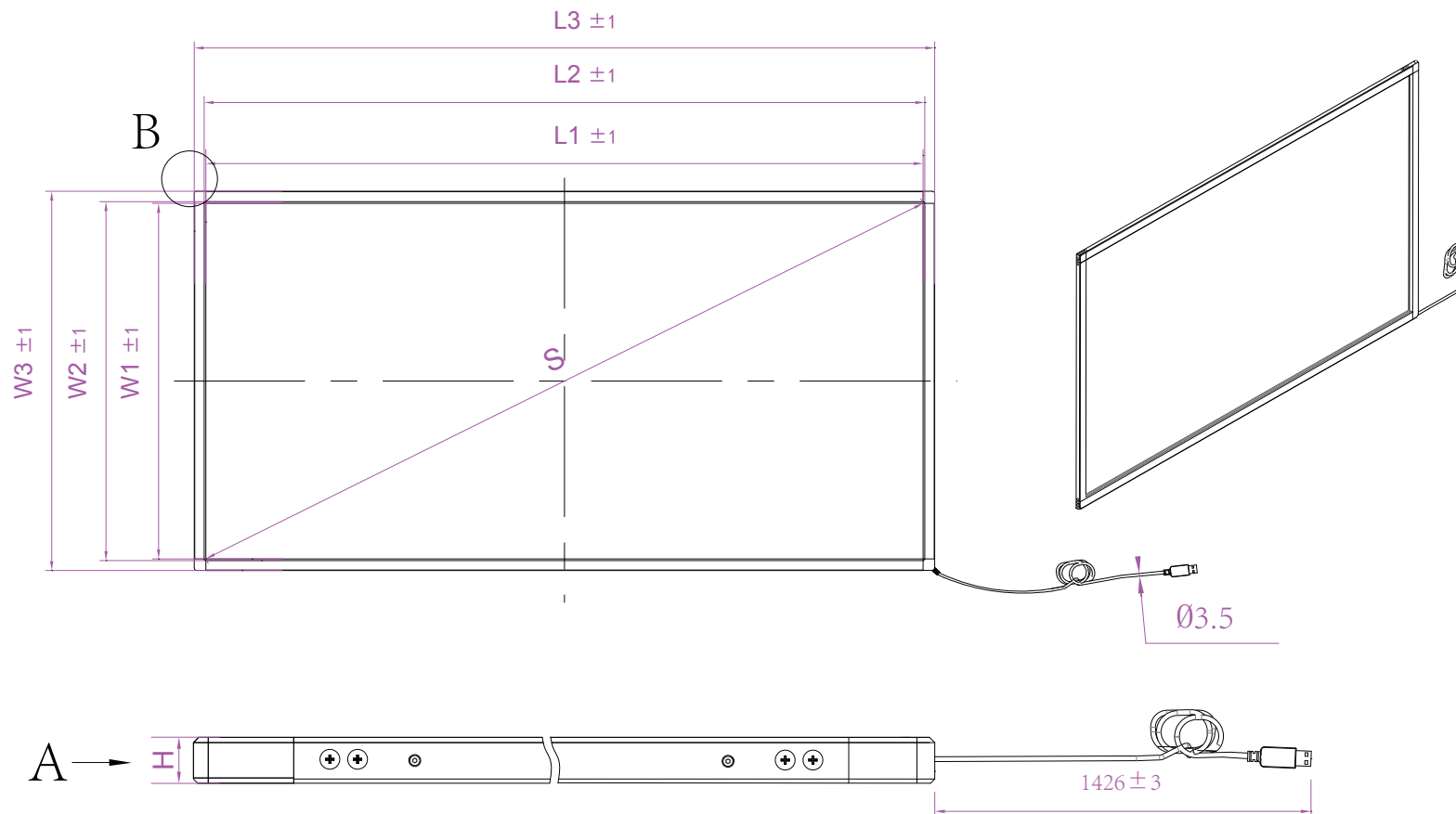
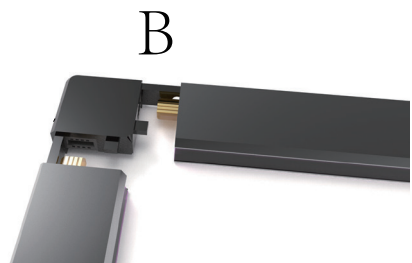

A

H

1426 ± 3

Ø3.5

S(Inch/mm)	31.74"/806.4
W1	395.8 ± 1
W2	398.4 ± 1
W3	433.8 ± 1
L1	702.6 ± 1
L2	705.2 ± 1
L3	740.6 ± 1
H	8.7 ± 0.2



Anti-Sunlight, No Blind Zone For Any Size



X Slim Series

Material:	aluminum	Unit:	mm	Date:		Rev:	1.0
Draft by:		Approved by:					

4

3

2

1